

250mA Low Quiescent Current CMOS LDO

DESCRIPTION

TS9011 is a positive voltage regulator developed utilizing CMOS technology featured very low power consumption, low dropout voltage and high output voltage accuracy. Built in low on-resistor provides low dropout voltage and large output current. A 1 μ F or greater can be used as an output capacitor. TS9011 are prevented device failure under the worst operation condition with both thermal shutdown and current fold-back. These series are recommended for configuring portable devices and large current application, respectively.

FEATURES

- Dropout Voltage 0.4V (typ.) @ I_o=250mA
- Output Current up to 250mA
- Low Power Consumption, 2 μ A (typ.)
- Output Voltage \pm 2%
- Internal Current Limit
- Thermal Shutdown Protection
- Compliant to RoHS Directive 2011/65/EU and in accordance to WEEE 2002/96/EC.
- Halogen-free according to IEC 61249-2-21

APPLICATION

- Battery-operated systems
- Microprocessor reset circuitry
- Memory battery back-up circuits
- Power-on reset circuits
- Power failure detection
- System battery life and charge voltage monitors



SOT-23

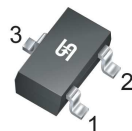

Pin Definition:

1. Ground
2. Output
3. Input

SOT-89

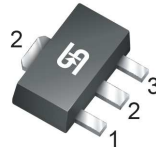

Pin Definition:

1. Ground
2. Input
3. Output

Notes: Moisture sensitivity level: level 3. Per J-STD-020

TYPICAL APPLICATION CIRCUIT

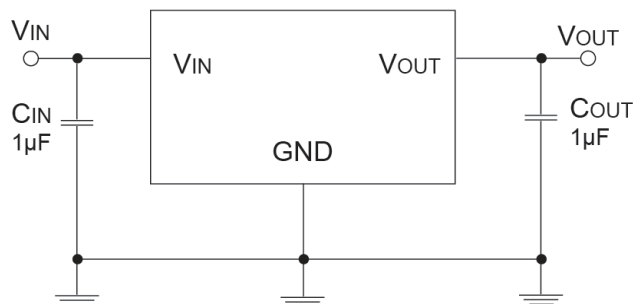

*Tantalum capacitor for Input & Output capacitor are recommended.

ABSOLUTE MAXIMUM RATINGS ($T_A = 25^\circ\text{C}$ unless otherwise specified) ^(Note 1)				
PARAMETER		SYMBOL	LIMIT	UNIT
Input Supply Voltage		V_{IN}	12	V
Output Current		I_{OUT}	250	mA
Power Dissipation	SOT-23	P_D	0.30	W
	SOT-89		0.50	
Operating Ambient Temperature		T_{OPR}	-40 ~ +85	$^\circ\text{C}$
Junction Temperature Range		T_J	-40 ~ +150	$^\circ\text{C}$
Storage Temperature Range		T_{STG}	-65 ~ +150	$^\circ\text{C}$

THERMAL PERFORMANCE				
PARAMETER		SYMBOL	LIMIT	UNIT
Thermal Resistance - Junction to Ambient	SOT-23	$R_{\theta JA}$	333	$^\circ\text{C/W}$
	SOT-89		200	

Note: Measured with FR4 4-layer board having thermal via holes

ELECTRICAL SPECIFICATIONS ($T_A = 25^\circ\text{C}$ unless otherwise specified)						
PARAMETER	CONDITION		MIN	TYP	MAX	UNIT
Output Voltage	$V_{IN}=V_O + 1V,$ $I_O=40mA,$	TS90115	4.90	5.0	5.10	V
		TS9011S	3.23	3.3	3.36	
		TS9011P	2.94	3.0	3.06	
		TS9011K	2.45	2.5	2.55	
		TS9011D	1.76	1.8	1.83	
Maximum Output Current	$V_{IN}=V_O+1V,$		250	--	--	mA
Input Stability	$V_O+1V \leq V_{IN} \leq V_O+2V, I_O=1mA$		--	0.2	0.3	%
Load Regulation ^(Note1)	$V_{IN}=V_O+1V,$ $1mA \leq I_L \leq 100mA$	TS90115	--	40	80	mV
		TS9011S				
	$V_{IN}=V_O+1V,$ $1mA \leq I_L \leq 80mA$	TS9011P	--	40	90	
		TS9011K				
Dropout Voltage ^(Note 2)	$I_O=250mA$	TS90115	--	400	600	mV
	$I_O=200mA$	TS9011S	--	400	650	
	$I_O=160mA$	TS9011P	--	400	700	
	$I_O=160mA$	TS9011K	--	400	700	
	$I_O=120mA$	TS9011D	--	400	750	
Quiescent Current	$V_{IN}=V_O+1V, I_O=0A$		--	2	5	μA
Output Current Limit	$V_{OUT} < 0.4V$		--	400	--	mA
Power Supply Rejection Ratio	At $f=100kHz, I_O=10mA,$		--	30	--	dB
Output Voltage Temperature Coefficient ^(Note 3)			--	100	--	ppm/ $^\circ\text{C}$

Note:

1. Regulation is measured at constant junction temperature, using pulsed ON time.
2. Dropout is measured at constant junction temperature, using pulsed ON time, and the criterion is V_{OUT} inside target value +/-2%.
3. Guaranteed by design.

ORDERING INFORMATION

OUTPUT VOLTAGE	PART NO.	PACKAGE	PACKING
1.8V	TS9011DCX RFG	SOT-23	3,000pcs / 7" Reel
	TS9011DCY RMG	SOT-89	1,000pcs / 7" Reel
2.5V	TS9011KCX RFG	SOT-23	3,000pcs / 7" Reel
	TS9011KCY RMG	SOT-89	1,000pcs / 7" Reel
3.0V	TS9011PCY RMG	SOT-89	1,000pcs / 7" Reel
3.3V	TS9011SCX RFG	SOT-23	3,000pcs / 7" Reel
	TS9011SCY RMG	SOT-89	1,000pcs / 7" Reel
5V	TS90115CX RFG	SOT-23	3,000pcs / 7" Reel
	TS90115CY RMG	SOT-89	1,000pcs / 7" Reel

FUNCTION BLOCK DIAGRAM

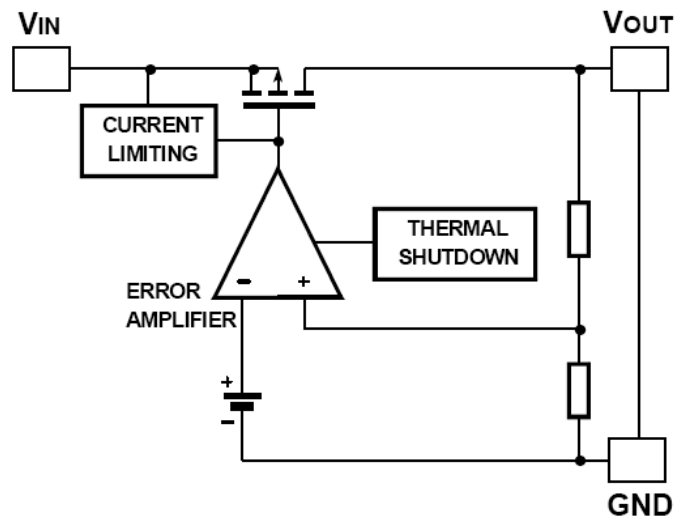

ELECTRICAL CHARACTERISTICS CURVES ($T_A=25^{\circ}\text{C}$, unless otherwise noted)

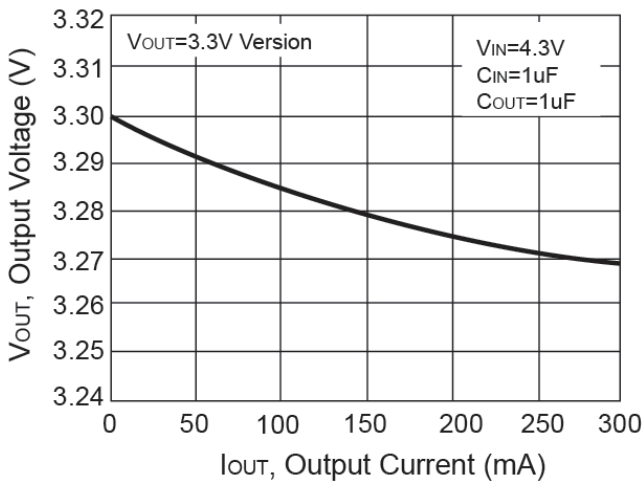

Figure 1. Output Voltage vs. Output Current

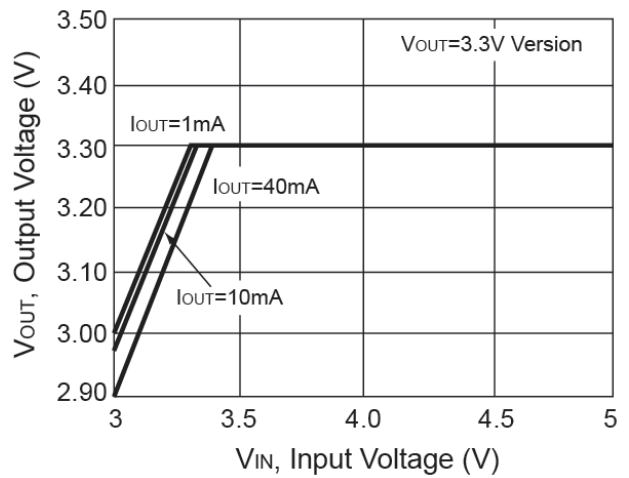

Figure 2. Output Voltage vs. Input Voltage

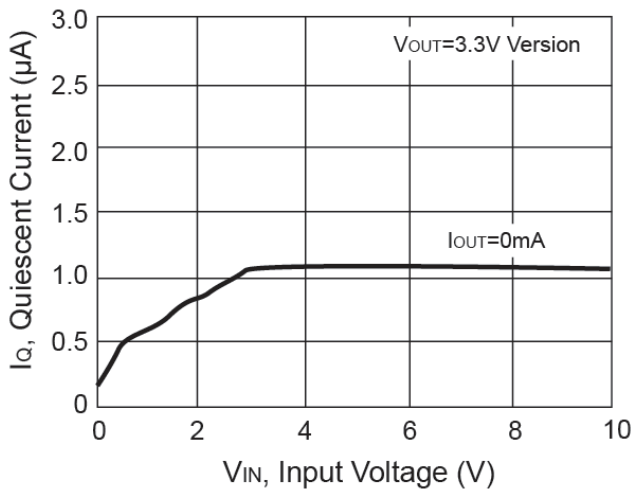

Figure 3. Quiescent Current vs. Input Voltage

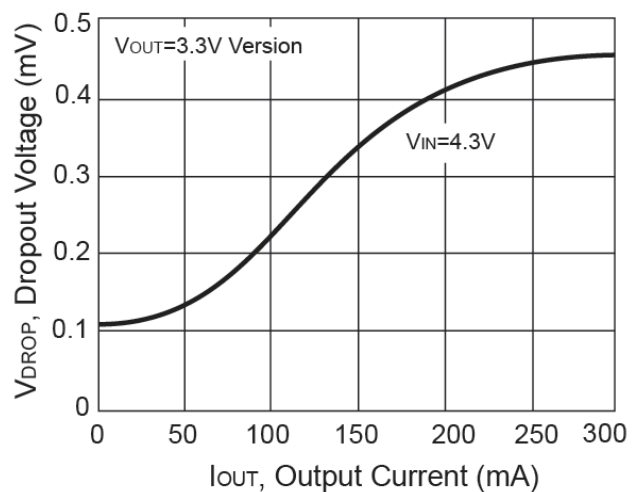
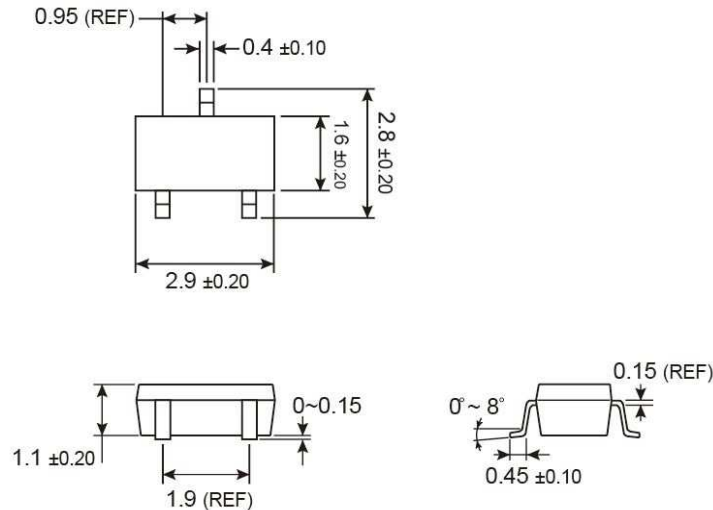

Figure 4. Short Circuit Current vs. Input Voltage

PACKAGE OUTLINE DIMENSIONS (Unit: Millimeters)

SOT-23



SUGGESTED PAD LAYOUT (Unit: Millimeters)

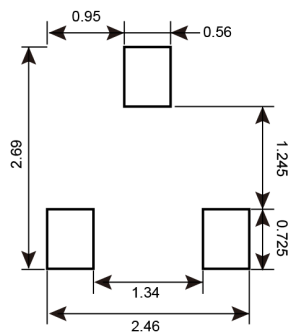

MARKING DIAGRAM

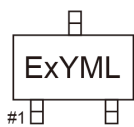

- E** = Product Code
- Y** = Year Code
- M** = Month Code for Halogen Free Product
 - O** =Jan **P** =Feb **Q** =Mar **R** =Apr
 - S** =May **T** =Jun **U** =Jul **V** =Aug
 - W** =Sep **X** =Oct **Y** =Nov **Z** =Dec
- L** = Lot Code (1~9, A~Z)
- X** = Fixed Output Voltage Code
 - A**=1.5V, **D**=1.8V, **K**=2.5V, **P**=3.0V, **S**=3.3V, **5**=5.0V.

PACKAGE OUTLINE DIMENSIONS (Unit: Millimeters)

SOT-89

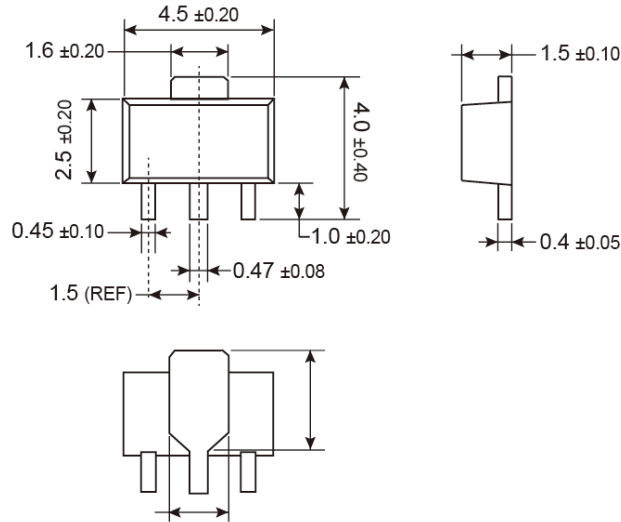

SUGGESTED PAD LAYOUT (Unit: Millimeters)

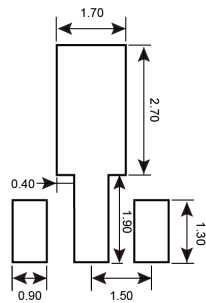

MARKING DIAGRAM

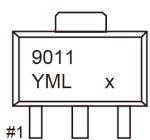

- Y** = Year Code
- M** = Month Code for Halogen Free Product
 - O** =Jan **P** =Feb **Q** =Mar **R** =Apr
 - S** =May **T** =Jun **U** =Jul **V** =Aug
 - W** =Sep **X** =Oct **Y** =Nov **Z** =Dec
- L** = Lot Code (1~9, A~Z)
- X** = Fixed Output Voltage Code
 - A**=1.5V, **D**=1.8V, **K**=2.5V, **P**=3.0V, **S**=3.3V, **5**=5.0V.